

1000TVL Colour Mini Dome Camera

Model: DB50-A10-28

High resolution, 1000TVL, 12V DC



Features:

- Metal-cased IP67 weatherproof dome with fixed lens.
- Low power consumption.
- Easy installation on ceiling or wall, surface or flush mount.
- 10 Infrared LEDs.

Operation procedures:

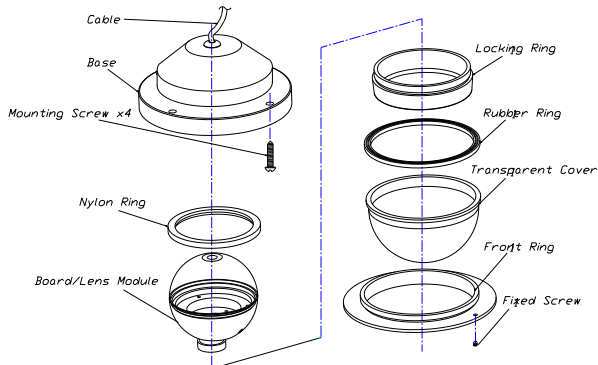

Use the attached hex key to loosen the hex head screw, then unscrew the top cover ~ if this is tight.

1. Attach the mounting base to wall or ceiling, as required. Use the supplied screws to fix camera in position.
2. Apply pressure to polycarbonate dome, and then move the ball to make the camera to the suitable position
3. Connect the camera as follows:



1---12VDC (+)
2---12VDC/GND (-)
3---Audio or N/A
4---Video

4. Replace the transparent cover and the top cover.
5. Re-tighten the hex-head screw to lock the dome camera.

Packing list:

Camera	1
Instruction manual	1
Hex-key	1
Mounting screw	4

Dimensions:

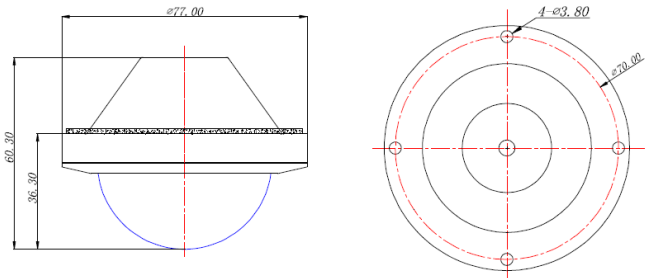

WARNING!

Apply firm hand-pressure to the polycarbonate to compress the o-ring seal while tightening the top cover. Only this will ensure an IP67 rating.

Specifications:

Model	DB50-A10-28
Image Sensor	1/3" CMOS AR0130
TV System	PAL/NTSC (optional)
Picture Elements	1280 (H) x 960 (V)
Sensitivity	0 Lux (IR LED On)
Scanning System	Progressive scan RGB CMOS
Synchronization	Internal
S/N Ratio	More than 44dB (AGC Off)
Auto Gain Control (AGC)	Auto
Electronic Shutter	Auto
BLC	Auto
Infrared Spectrum	940nm
Infrared LED	10 LEDs
Video Output	1 Vp-p, 75Ω, CVBS
Audio	Optional
Mirror	Optional
ICR	N/A
Noise Reduction	3D
Dynamic range	83.5 dB
Lens	F2.8mm Megapixel
Power Supply	9-18V DC
Power Consumption	160mA
Dimensions (Ø X H)	77 x 60.3 mm
Net Weight	200 g
Weatherproof	IP67
Operating Temperature	-30° C ~ +70 ° C

*Specifications are subject to change without prior notice.